

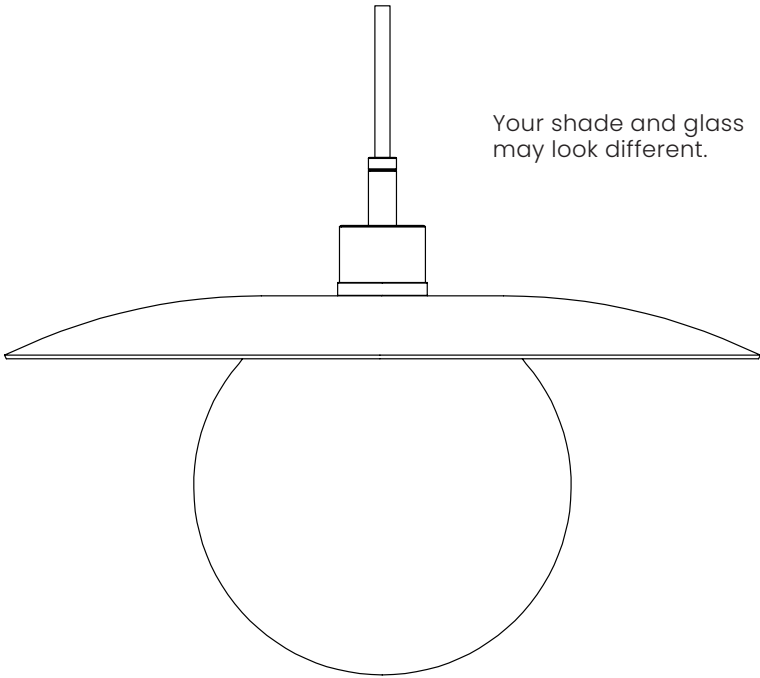

Socket + Shade + Glass

VIRO-0028-XXXXXXXX

Assembly Instructions



Your shade and glass
may look different.

Questions?

Email: support@virolighting.com

Phone: 385-799-6966



THIS PRODUCT MUST BE INSTALLED IN ACCORDANCE WITH THE APPLICABLE INSTALLATION CODE BY A PERSON FAMILIAR WITH THE CONSTRUCTION AND OPERATION OF THE PRODUCT AND THE HAZARDS INVOLVED

Included Tools

Mini flathead screwdriver
Allen wrench

Tools Needed

Phillips head screwdriver
Wire stripper
Electrical tape

1. **Do not** cut the cord until you complete the assembly of your fixture.



2. Before installing, turn off power at the circuit breaker or fuse box. Failure to do so may result in serious injury or electrical shock.

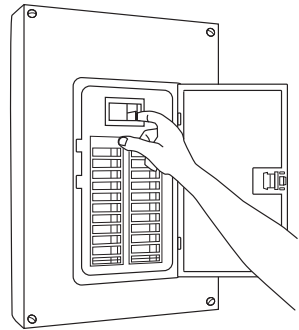



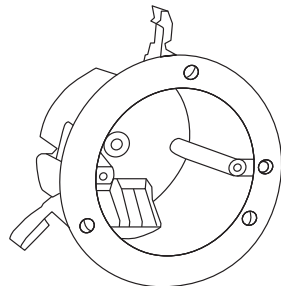

3. A 4" round junction box or smaller, rated for ceiling pendants is required for install (not included).

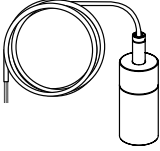

Parts List - Names and Quantities

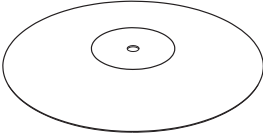
VIRO-0028-XXXXXXXX

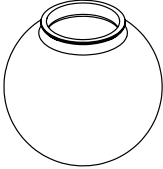
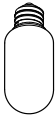
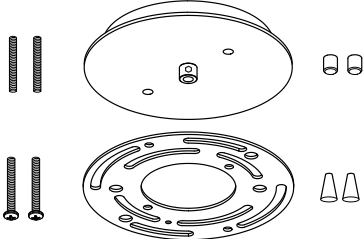
	<p>1 Socket + Cord VIRO-PEN-0001-XXX</p>
	<p>1 Check Ring A VIRO-COM-0007-XXX</p>
	<p>1 Shade Your shade may look different. VIRO-SHD-XXXX-XXX</p>
	<p>1 Glass Adapter Cap VIRO-COM-0010-XXX</p>
	<p>1 Glass Adapter + 3 Set Screws VIRO-COM-0009-BLK</p>
	<p>1 Glass Your glass may look different. VIRO-GLS-XXXX-XXX</p>
	<p>1 Bulb Your bulb may look different.</p>
	<p>1 Canopy + 1 Universal Mount 2 8-32 Junction Box Screws 2 Canopy Mount Threaded Rods 2 Locking Nuts 2 Wire Nuts VIRO-CAN-0001-XXX</p>

Step 1: Disassemble the Socket

Hand unscrew each part in the order shown. Slide them off the cord **one at a time** and place them to the side for reassembly.

ATTENTION: **slowly** slide parts off and on the cord so you don't fray the cord. Any fraying that does occur can be removed by gently brushing the cord with a lighter.

ATTENTION: If untwisting the bottom portion of the socket, **avoid applying excessive force**, as it may damage the wires.

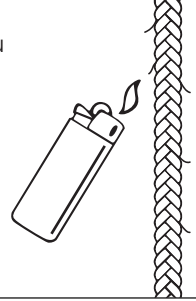

Start here:

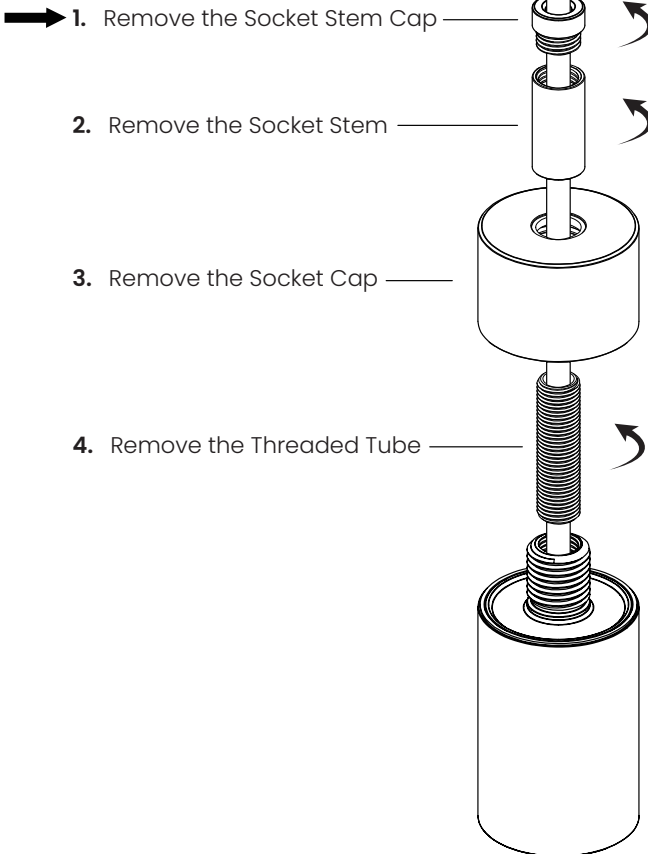

Step 2: Assemble the Fixture

Assemble the following parts, one at a time:

3. Assemble the Check Ring A

2. Assemble the Shade

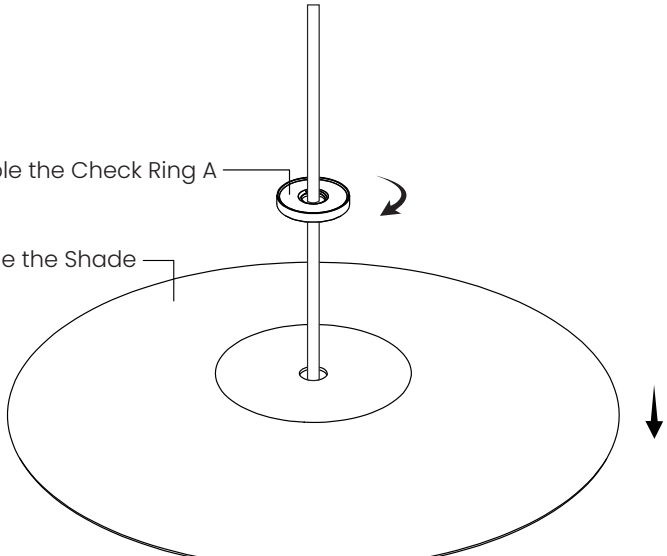





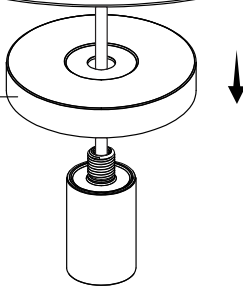

Start here:





1. Assemble the Glass Adapter Cap



Assemble the following parts, one at a time:

4. Assemble the Socket Stem Cap —  
3. Assemble the Socket Stem —  
2. Assemble the Socket Cap —  

Start here:

-  1. Assemble the shorter Threaded Tube from the Socket —  

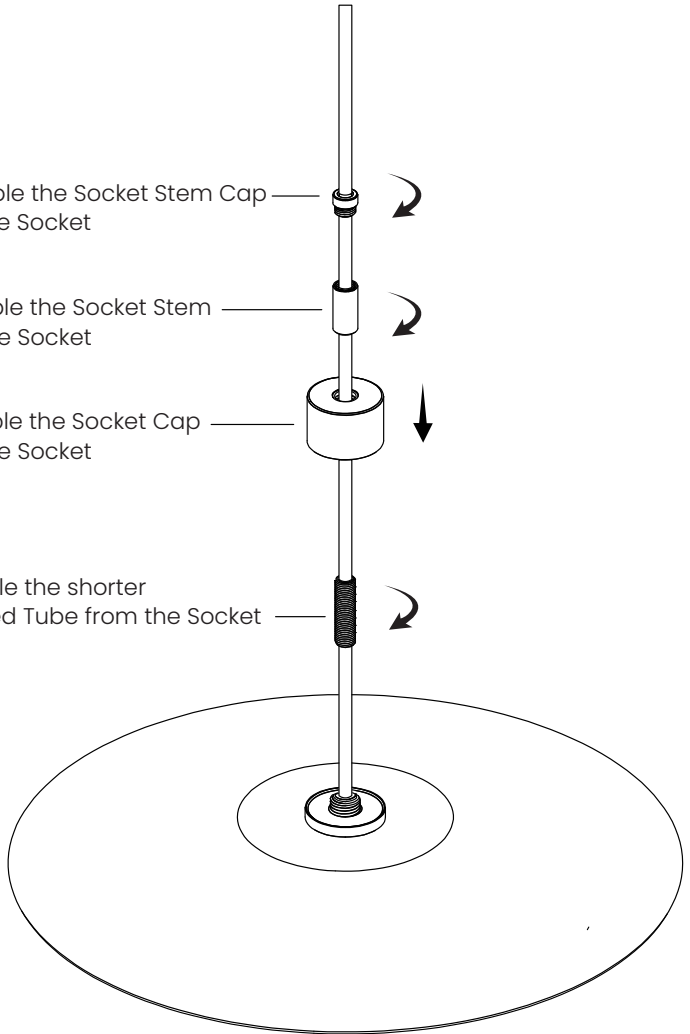

Attach the Glass Adapter to the top of the Glass.

1. Before placing the Glass Adapter on the glass, **remove any obstructions or residue** surrounding the inside of the three drill holes. This will prevent you from stripping the set screws.

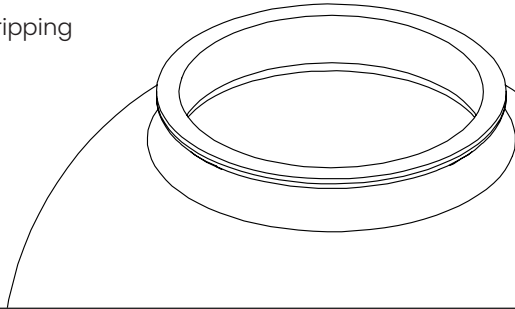
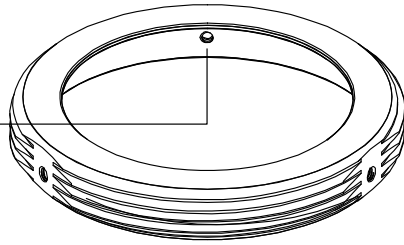

2. Using the included flat head screwdriver, carefully screw the included set screws into place until they are flush with the Glass Adapter. **Do not overtighten or strip** the screws.

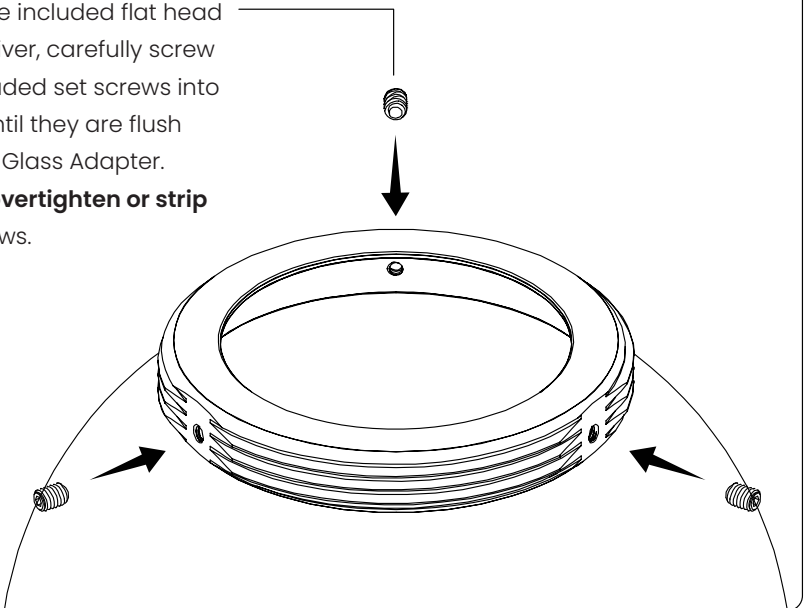

Step 5: Assemble the Bulb and Glass

**Install the Bulb and securely attach the Glass to the Fixture.
Be sure not to overtighten the Glass.**

1. Assemble the Bulb

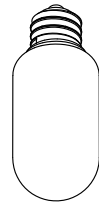

2. Assemble the Glass

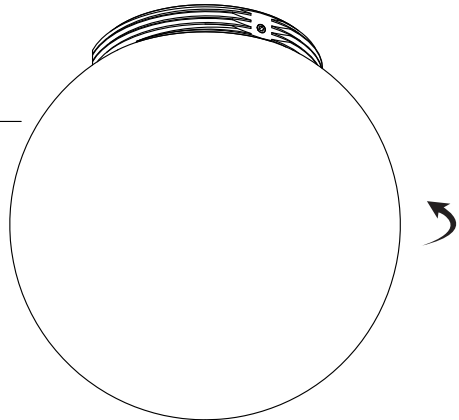

If you plan to use the entire length of the cord, then you may skip this step.

1. Cut the Cord

Determine the desired length of the Cord by holding the Cord up to the ceiling. The cut mark should be about 6" above that length.

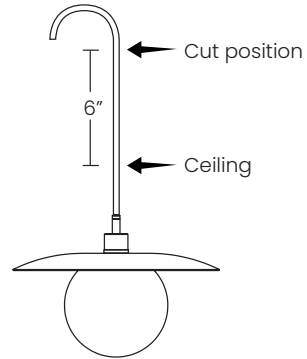

2. Remove Outer Housing

Moving about 2" from the new end of the cord, use the wire stripper to gently score into and around the Fabric Cord. Do this a few times until you can twist and pull away the outer housing to expose the wires. Be careful not to cut into any of the wires.

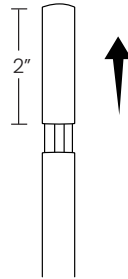

3. Tape the Cord

Use a thin strip of electrical tape to tape the fabric to the wires to prevent the fabric from sliding down. (If the tape is too thick you will not be able to slide the cord through the canopy).

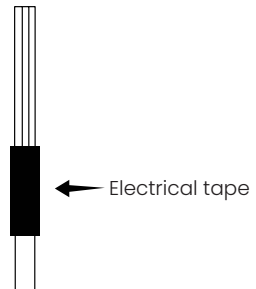

1. Strip the Wiring (if necessary)

If you cut the Cord on the previous page, expose the wiring by removing about 1/2" of insulation on all three wires. Using a wire stripper, clamp down on each wire and pull off the insulation.

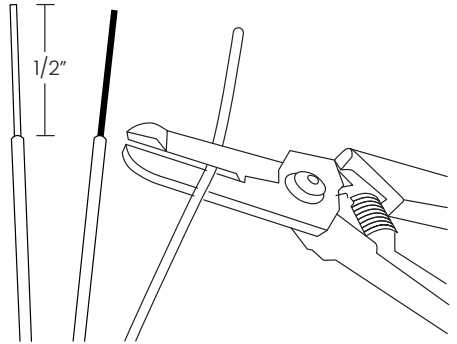

2. Slide the Cord into the Canopy

Before installing the Canopy, insert the Cord into the Canopy and lock it tightly into place by using the included set screw and allen wrench.

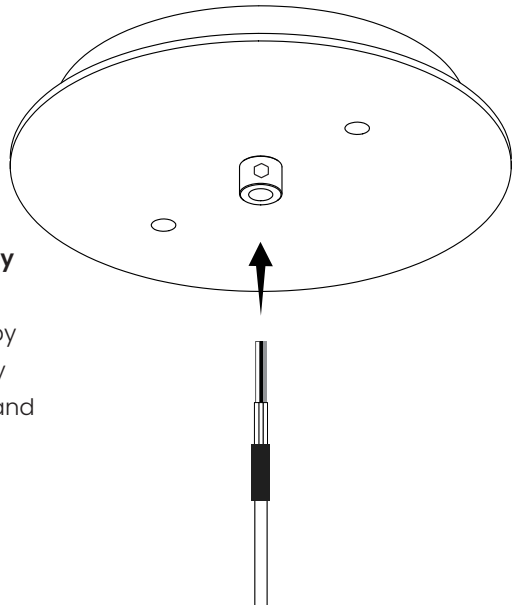

Step 8: Prepare the Canopy

1. Install the Universal Mount (Included with the Canopy)

Using the included screws, attach the Universal Mount onto the ceiling junction box.

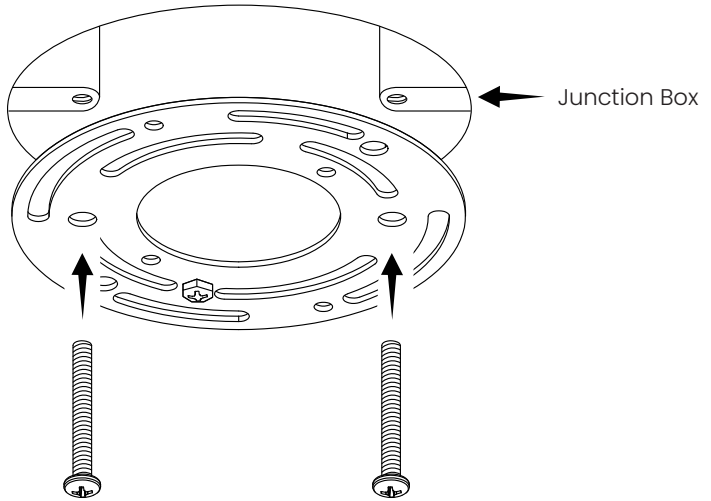

2. Install the Canopy Mounting Rods (Included with the Canopy)

Screw the Threaded Rods into the Universal Mount.

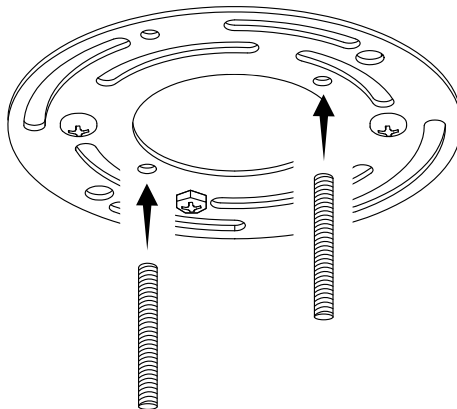

ATTENTION: Another set of hands to help hold the fixture during installation is strongly recommended. It may also help to remove the Glass and Bulb to make the fixture lighter.

1. Connect and Cap the Wiring

Match the ground wire (green) to the ground screw. Match the power wire (black) to the corresponding power wire and cap the connection. Match the neutral wire (white) to the corresponding neutral wire and cap the connection.

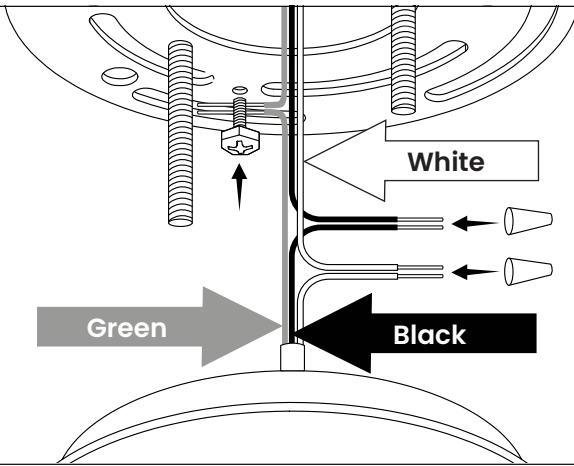

2. Align the Canopy

Slide the Canopy into place by aligning the Canopy onto the Mounting Rods.

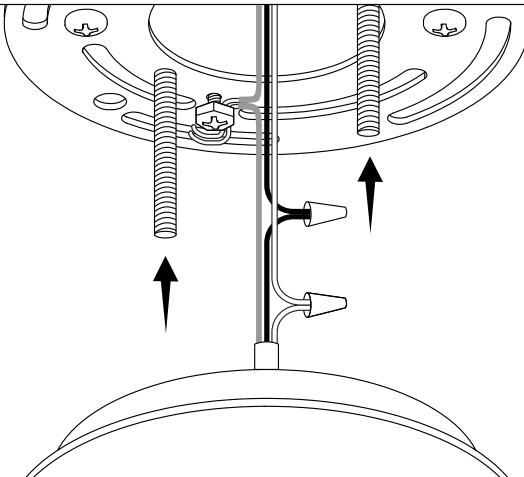

1. Screw the Locking Nuts onto the Canopy Mounting Rods to lock the Canopy into place.

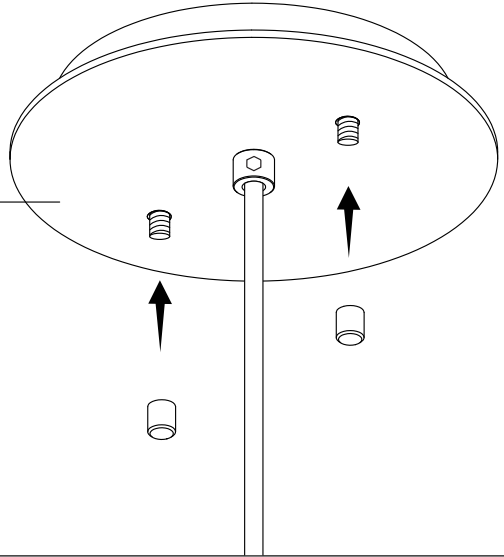

2. Download the Viro app

If you purchased a Smart Bulb:

Utilize all the capabilities of your Smart Bulb by connecting it to our Viro app. To do so, download the app and follow the prompts.



When you first turn on your fixture, your Smart Bulb will begin to flash. The flashing indicates that the Bulb is ready to pair with the app. Once you sync the Bulb with the app, the flashing will stop.

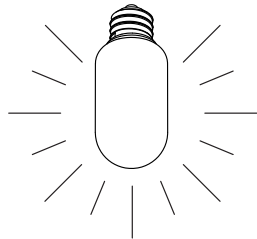

Register your fixture

Get access to faster support and important updates. It only takes a minute.



Leave a review

Help us improve the product and install experience.



Share your finished installation

We'd love to see how it looks in your home! Use hashtag #virolighting and tag us.



Thank you for your purchase!



www.virolighting.com