

Included Components

- Hardware Packet R, with Instructions
- Parallel Glass Panels (QTY:24) or Blown Glass (QTY:12)
- Canopy
- Braided Fabric Cord (QTY:12)
- Cord grip (QTY:12— Attached to canopy)
- Cylinder Knobs (QTY:4)

Required Tools

- Allen Key (provided)
- Philips screw driver (not provided)
- Wire cutters/strippers (not provided)
- Measuring tape (not provided)

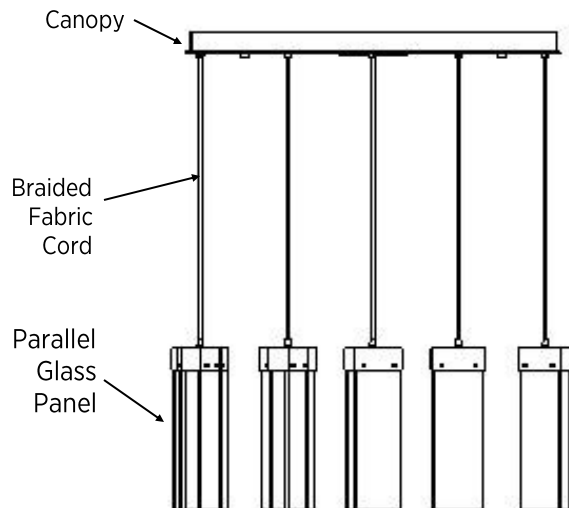
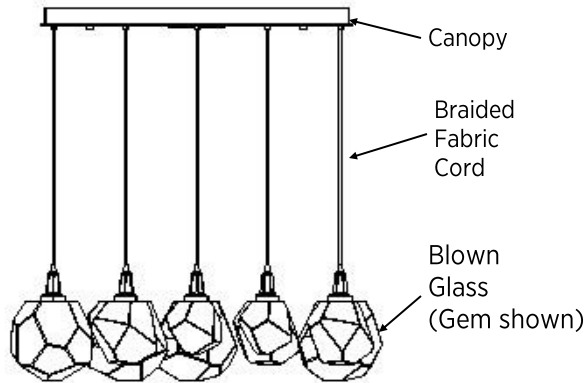

Assembly Instructions

Step 1: Feed the braided fabric cord into the canopy until the desired amount of cord is left between the canopy and light body. Take into account that a minimum of 6" of cord will be required for connecting the wiring to the driver.

Step 2: Use the measuring tape to be sure that all of your light body is hanging the proper distance from the canopy. Tighten the cord grip using a flat blade screw driver. The cord grip is on the face of the canopy. **DO NOT OVER TIGHTEN. THIS MAY DAMAGE THE FIXTURE.**

Step 3: Make wire connections to the driver using the installed terminal block. Connect any pendant to an available terminal housing.

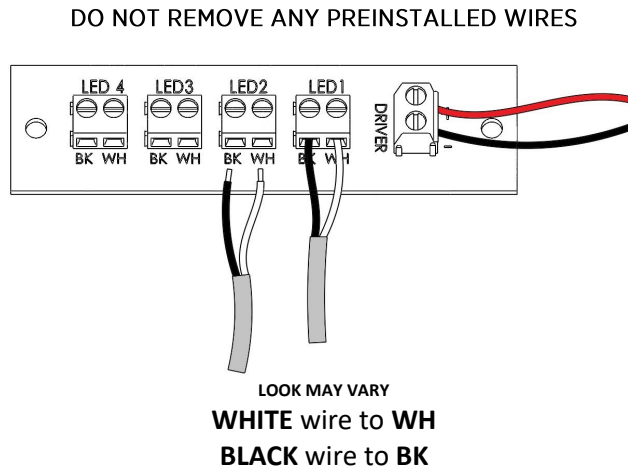

Make wire connections from driver to source power. **WHITE** to **WHITE**, **BLACK** to **BLACK**, and ground the fixture to the canopy.

WARNING

DO NOT DIRECTLY CONNECT LEDs TO AC POWER. LEDs will be damaged if exposed to high voltages. The LED's must be wired in series to work properly.

Step 4: Mount the canopy to the ceiling using the provided **Mounting Instructions**.

Step 5: Attach glass to LED pendant housing

Gem, Rock Crystal, Aalto, Fiori, Blossom, Ice Fall, Gaia, Mesa, Vessel, and Raindrop	
1- Screw glass either into or onto threaded pendant housing. (Raindrop: Place diffuser inside glass before threading)	
Ledgestone 1- Insert glass into housing and secure with provided set screws.	Parallel Glass 1- Slide glass into housing and secure with cylinder knobs and all thread.
Nebula 1- Screw inner glass into socket. 2- Un-screw retention nut and lift top cap. 3- Slide outer glass over inner glass and retention plate and rest on plate. 4- Rotate glass so that the maximum surface area is in contact with retention plate. 5- Lower top cap and tighten retention nut.	Axis 1- Un-screw retention nut and lift top cap. 2- Align grooves and nylon mounts and slide glass in. 3- Lower top cap and tighten retention nut.
For all Glass Retention Tighten till snug DO NOT overtighten	

About Hammerton Studio

HAMMERTON STUDIO

When we introduced the Hammerton Studio brand in 2014, we saw an enormous opportunity to raise the bar in decorative lighting. In design, we wanted to lead rather than follow. In construction, we wanted to showcase Hammerton's renowned reverence for time-honored artisan craftsmanship and authentic materials. In performance, we wanted to provide highly reliable solutions that far exceeded industry norms for aesthetics, function, and quality. Based on the brand's dramatic growth and customer feedback, it's clear we are on the right track.

EXTRAORDINARY DESIGN VALUE IN ARTISAN GLASS & METALWORK

Hammerton began in 1995 as a blacksmith shop, but we've come a long way since then. Today we employ a world class team of metal artisans who are disciplined in a broad range of fabrication techniques and processes. We've also added in-house capabilities in blown, cast and kiln-fused glass, and today Hammerton operates one of the largest artisan glass production facilities in the U.S. With deep design and fabrication expertise at the intersection of glass and metalwork, we're laying the foundation for a new era of lighting innovation.

THE HAMMERTON HERITAGE

Our Hammerton Studio brand stands on the shoulders of more than a quarter century of experience pushing the boundaries of innovative custom lighting design. Each Hammerton Studio collection has been inspired by custom work our company has brought to life in collaboration with leading interior design professionals over the years. Built to your specifications, every fixture reflects the uncompromising design and attention to detail that is distinctly Hammerton.

A REPUTATION REFLECTED BY OUR CLIENTS

Hammerton fixtures are as extraordinary as the clients who purchase them, including Forbes 400 members, Fortune 500 leaders, award-winning entertainers, fashion and interior designers, sports legends, and leading luxury hospitality brands.

Hammerton Inc.
217 Wright Brothers Drive
Salt Lake City, UT 84116

801-973-8095 EXT: 4
www.hammerton.com

Warranty

Please visit <https://studio.hammerton.com/lifetime-limited-warranty/> to view the Hammerton Studio Warranty Policy.

HAMMERTONSTUDIO™

Assembly Instructions

CHB0039-12, CHB0042-12, CHB0045-12, CHB0049-12, CHB0050-12, CHB0056-12, CHB0060-12, CHB0066-12, CHB0067-12, CHB0068-12, CHB0069-12, CHB0078-12, CHB0107-12

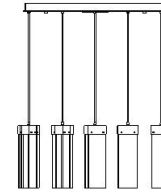

Parallel
CHB0042-12

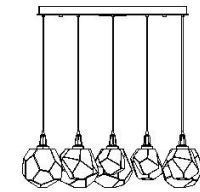

Gem
CHB0039-12

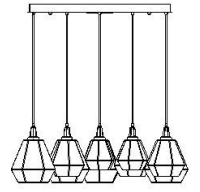

Hedra
CHB0045-12



Aalto
CHB0049-12

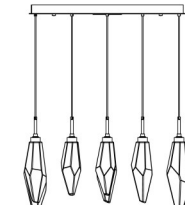

Rock Crystal
CHB0050-12

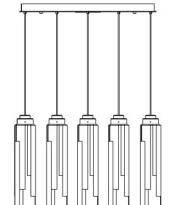

Ledgestone
CHB0056-12

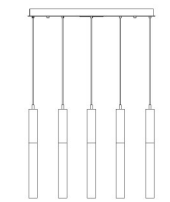

Axis
CHB0060-12

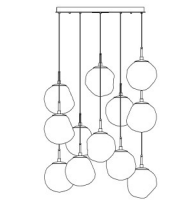

Nebula
CHB0066-12

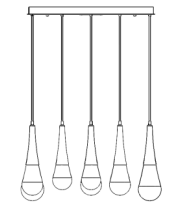

Raindrop
CHB0078-12

**WARNING: FAILURE TO INSTALL THIS
FIXTURE PROPERLY MAY RESULT IN
SERIOUS PERSONAL INJURY OR DEATH
AND PROPERTY DAMAGE.**

It is recommended that this product be installed by a licensed electrician who is familiar with proper LED installation and electrical loads.

41-001-00045
Rev 14