

Included Components

- Hardware Packet T with Instructions
- Toggle Bolts and Washers (QTY: 3)
- Canopy and Light Body
- LED Assembly (QTY: 3)
- Handblown Glass (QTY: 3)

Required Tools

- Philips screw driver (not provided)
- Wire cutters/strippers (not provided)

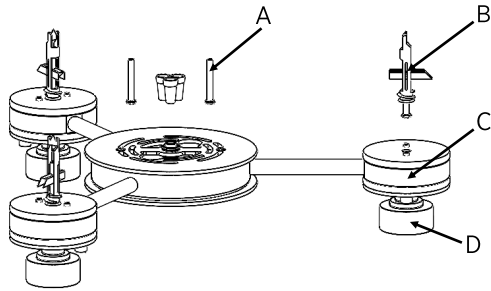

SMB0039-H3 Shown as Example

Assembly Instructions

Step 1: TURN OFF POWER TO JUNCTION BOX TO BE USED FOR INSTALLATION.

WARNING: Failure to use the LED driver to power your fixture will permanently damage your product making it unusable

Step 2: Remove Canopy Universal from light fixture by removing the Large cylinder knob and unscrewing the 2 Phillips screws beneath the cover plate.

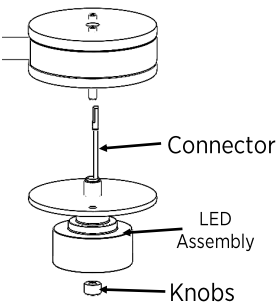
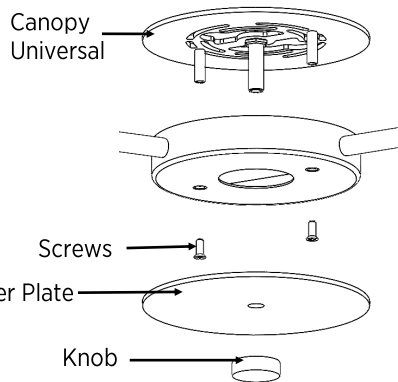

Step 3: Remove the 3 LED Assemblies from light fixture by removing the 2 cylinder knobs and detaching the electrical connector. Set aside for later installation.

Step 3: Follow mounting packet T instructions to attach canopy universal to ceiling. **Note: Standoff orientation affects fixture orientation.**

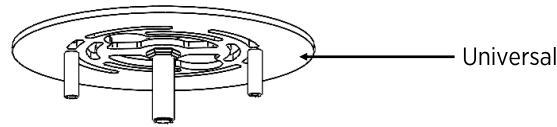

Step 4: Refer to mounting template instructions 41-001-00300 to mark mounting locations onto the wall/ceiling.

Step 5: Follow the first step of the toggle bolt instructions on the following page to attach toggle bolts to dry-wall at each of the 3 locations you marked.

WARNING

The PURPLE and RED leads from the driver are for DC current only. If these leads or the LED Assembly are connected to AC power the fixture will be damaged.

Step 6: Make wire connections from driver to source power as per mounting packet T instructions.

Step 7: Reattach canopy to universal using flathead screws, and close the center assembly with the large cylinder knob and faceplate.

Step 8: Follow the rest of the toggle bolt instructions on the following page to attach the 3 hubs to the wall using the toggle bolts. Be sure to use the included washers (shown below)

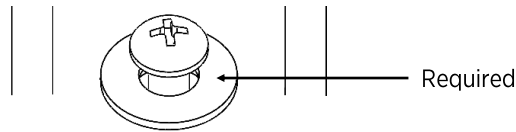

Step 9: Attach male electrical connector (shown left) connected to the LED Assemblies (D) to the female electrical connectors inside of the outer hubs. Ensure that wire runs through the center hole, and not around it to prevent any potential shorts (shown right). **Note: For Luna glass, glass installation is required prior to LED assembly installation. Return to this step once glass is installed.**

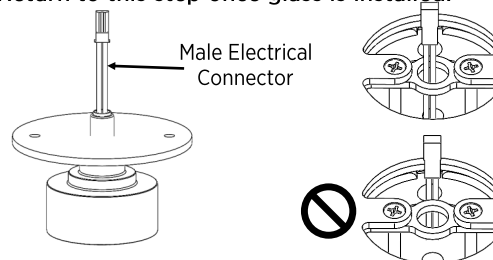

Step 10: Secure LED assemblies to the hubs using the 2 provided cylinder knobs.

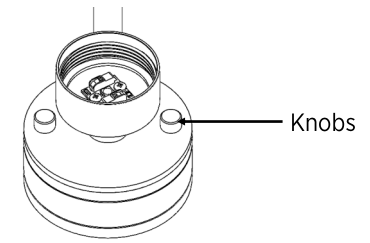

Glass Installation

Step 13: Install glass by screwing the threaded collar on the glass onto the threaded cup.

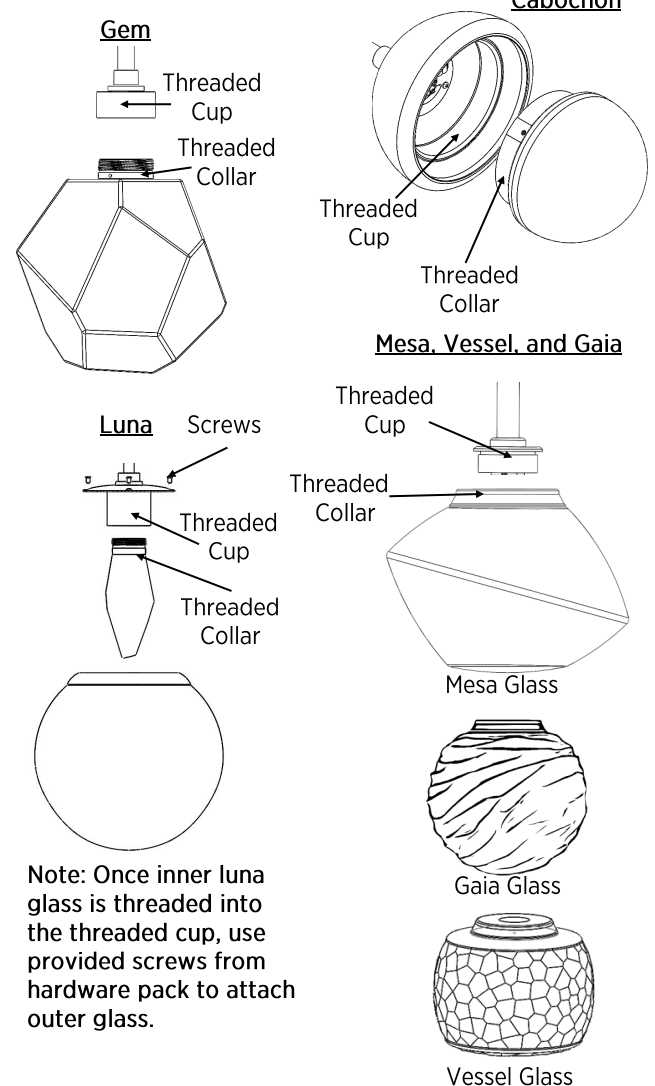

Note: Once inner luna glass is threaded into the threaded cup, use provided screws from hardware pack to attach outer glass.

About Hammerton Studio

HAMMERTON STUDIO

When we introduced the Hammerton Studio brand in 2014, we saw an enormous opportunity to raise the bar in decorative lighting. In design, we wanted to lead rather than follow. In construction, we wanted to showcase Hammerton's renowned reverence for time-honored artisan craftsmanship and authentic materials. In performance, we wanted to provide highly reliable solutions that far exceeded industry norms for aesthetics, function, and quality. Based on the brand's dramatic growth and customer feedback, it's clear we are on the right track.

EXTRAORDINARY DESIGN VALUE IN ARTISAN GLASS & METALWORK

Hammerton began in 1995 as a blacksmith shop, but we've come a long way since then. Today we employ a world class team of metal artisans who are disciplined in a broad range of fabrication techniques and processes. We've also added in-house capabilities in blown, cast and kiln-fused glass, and today Hammerton operates one of the largest artisan glass production facilities in the U.S. With deep design and fabrication expertise at the intersection of glass and metalwork, we're laying the foundation for a new era of lighting innovation.

THE HAMMERTON HERITAGE

Our Hammerton Studio brand stands on the shoulders of more than a quarter century of experience pushing the boundaries of innovative custom lighting design. Each Hammerton Studio collection has been inspired by custom work our company has brought to life in collaboration with leading interior design professionals over the years. Built to your specifications, every fixture reflects the uncompromising design and attention to detail that is distinctly Hammerton.

A REPUTATION REFLECTED BY OUR CLIENTS

Hammerton fixtures are as extraordinary as the clients who purchase them, including Forbes 400 members, Fortune 500 leaders, award-winning entertainers, fashion and interior designers, sports legends, and leading luxury hospitality brands.

Hammerton Inc.
217 Wright Brothers Drive
Salt Lake City, UT 84116

801-973-8095
info@hammerton.com
www.hammerton.com

Warranty

Please visit:
<https://studio.hammerton.com/lifetime-limited-warranty/>
to view the Hammerton Studio Warranty Policy

HAMMERTONSTUDIO™

Assembly Instructions 3 Piece Surface Mount

SMB0039-H3, SMB0089-H3, SMB0091-H3,
SMB0092-H3, SMB0093-H3, SMB0095-H3,

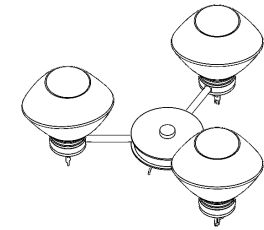

SMB0089-H3

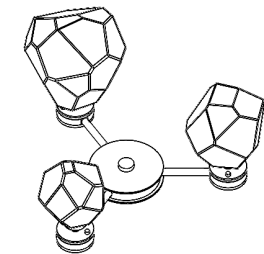

SMB0039-H3

WARNING: Failure to use the LED driver to power your pendant will permanently damage your product making it unusable.

WARNING: FAILURE TO INSTALL THIS
FIXTURE PROPERLY MAY RESULT IN
SERIOUS PERSONAL INJURY OR DEATH
AND PROPERTY DAMAGE.

It is recommended that this product be installed
by a licensed electrician.

41-001-00301
Rev 2

E-Z Toggle™ Instructions



Turn E-Z Toggle into drywall until seated flush. Arrows on head indicate direction toggle clamp will open. End with arrows up and down.

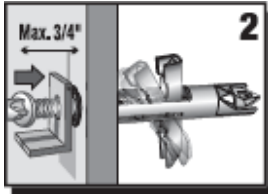

Place fixture over E-Z Toggle. Push screw into E-Z Toggle to engage clamp

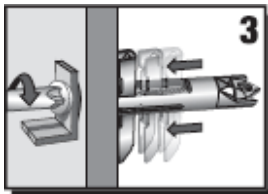

Turn screw until it stops. Toggle clamp tightens against drywall as screw is turned.