



## Iris 6-Piece Mobile

### Finishes



Burnished  
Bronze (BB)



Beige Silver  
(BS)



Classic  
Silver (CS)



Flat Bronze  
(FB)



Gilded Brass  
(GB)



Graphite  
(GP)



Matte Black  
(MB)



Novel Brass  
(NB)

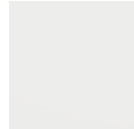

Salt White  
(WI)

### Glass Options

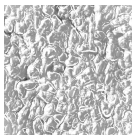

Cast Glass  
Clear (GL)

### Accent



Nutmeg  
Leather  
(L01)

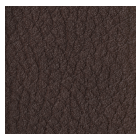

Cocoa  
Leather  
(L02)

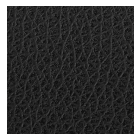

Licorice  
Leather  
(L03)



Matching  
(00)



Matte Black  
(MB)

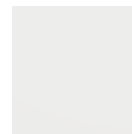

Salt White  
(WI)



Light Oak  
Wood (W01)

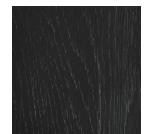

Dark Oak  
Wood (W02)



Ash Wood  
(W03)

### Product Notes - PLEASE READ:

- All Hammerton Studio fixtures are handcrafted by artisans. Subtle imperfections reflect the mark of the maker and should be expected.
- This product may incorporate both steel and aluminum material. Transparent finishes may vary between steel and aluminum components.
- Products incorporating artisan blown and cast glass may create dramatic patterns of light and shadow on surrounding surfaces. While this is often desirable, shadowing can be minimized by adding recessed ceiling light to the installation area.

### General Notes:

- Visit [studio.hammerton.com](http://studio.hammerton.com) to read our complete warranty.
- All dimensions are in inches unless otherwise noted. Dimensions may vary up to 7/8".

Revision date: 2025-12-23

Scan for Product &  
[Install Info](#)



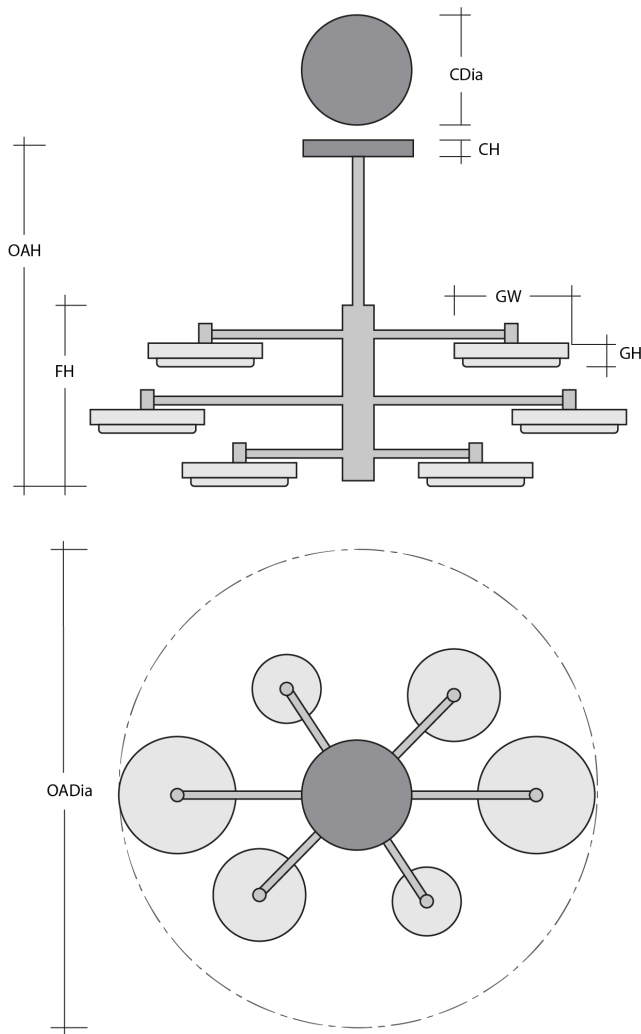

## Iris 6-Piece Mobile

### Product Dimensions *Dimensions may vary up to 7/8"*

Overall Height	OAH	24 – 81 in
Overall Diameter	OADia	49 in
Canopy Height	CH	1.2 in
Canopy Diameter	CDia	9 in
Fixture Height	FH	15.4 in

### Glass Dimensions

Glass Height	GH	2.16 in
Large Qty		2
Large Glass Width	GW	12 in
Medium Qty		2
Medium Glass Width	GW	10.25 in

### Electrical

Bulb/Lamping Qty		6
Bulb/Lamping Type		LED
Wattage		44 watts
Voltage		120 volts
Total Source Lumens		3890 lumens
Dimming Type		TRIAC/ELV
Correlated Color Temp: CCT		2700K or 3000K
Color Rendering Index: CRI		93+
Certification		ETL

### Installation & Mounting

Weight: Lbs		92 lbs
Mounting Type		Structural
Suspension Type		Rod
Flat or Sloped		Sloped
Max Slope	SA	25 degrees
Location		Indoor/Dry

### Other Information

Warranty		See Website
----------	--	-------------

### Project Notes

Name:

Location:

Quantity:

Finish Color:

Glass Color:

Notes: