

Disc Surface Mount - Cumulus - Medium (pressed metal disks)

Suitable for both walls and ceilings, this playful design creates a captivating focal point on any interior surface. Choose an all-metal look with either a single or two-tone finish, or pair metal with a glass diffuser.

Finishes

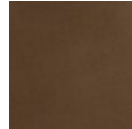

Burnished Bronze (BB)

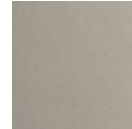

Beige Silver (BS)

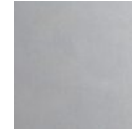

Classic Silver (CS)

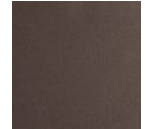

Flat Bronze (FB)



Gilded Brass (GB)



Graphite (GP)



Matte Black (MB)



Novel Brass (NB)

Accent



Smoke Granite (SG)



Clear Granite (CG)



Accent color matches fixture color (MI)

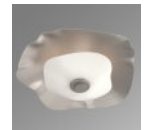

Salt White (WI)

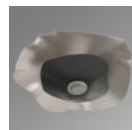

Matte Black (BI)

Product Notes - PLEASE READ:

- All Hammerton Studio fixtures are handcrafted by artisans. Subtle imperfections reflect the mark of the maker and should be expected.
- This product may incorporate both steel and aluminum material. Transparent finishes may vary between steel and aluminum components.
- Products incorporating artisan blown and cast glass may create dramatic patterns of light and shadow on surrounding surfaces. While this is often desirable, shadowing can be minimized by adding recessed ceiling light to the installation area.

General Notes:

- Visit studio.hammerton.com to read our complete warranty.
- All dimensions are in inches unless otherwise noted. Dimensions may vary up to 7/8".

Revision date: 2025-04-03

[Scan for Product & Install Info](#)



Disc Surface Mount - Cumulus - Medium (pressed metal disks)

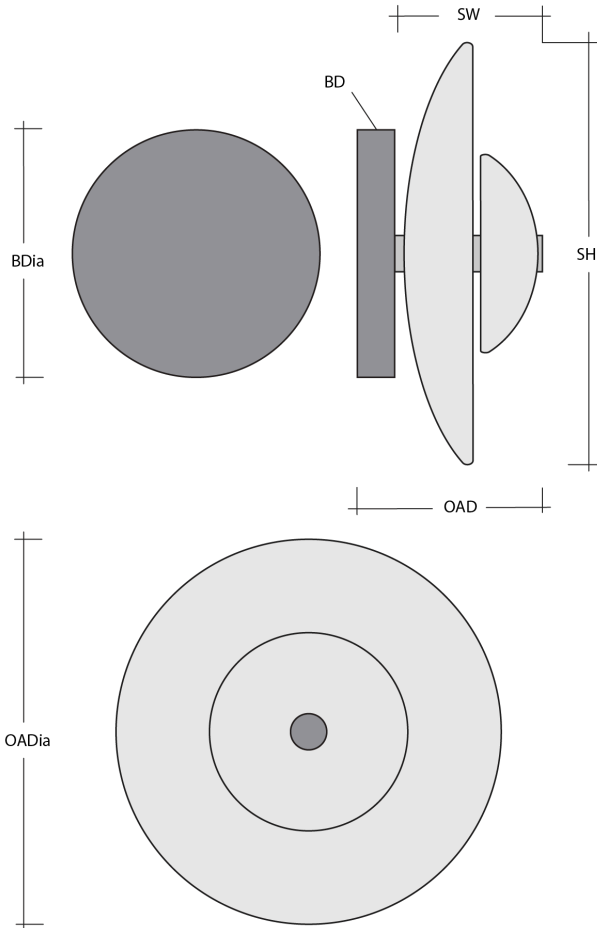

Product Dimensions *Dimensions may vary up to 7/8"*

Overall Depth	OAD	6.5 in
Overall Diameter	OADia	14 in
Backplate Depth	BD	1.2 in
Backplate Diameter	BDia	6 in

Shade Dimensions

Medium Shade Qty		1
Medium Shade Height	SH	14 in
Medium Shade Width	SW	5.2 in

Electrical

Bulb/Lamping Qty	1
Bulb/Lamping Type	LED
Wattage	4 watts
Voltage	120 volts
Total Source Lumens	340 lumens
Dimming Type	TRIAC/ELV
Correlated Color Temp: CCT	3000K
Color Rendering Index: CRI	93+
Certification	ETL

Installation & Mounting

Weight: Lbs	7 lbs
Mounting Type	J-Box
Minimum J-Box size	4L X 4W X 1.5D in
Flat or Sloped	Sloped
Slope Orientation	All
Location	Indoor/Dry

Other Information

Warranty	See Website
----------	-------------

Project Notes

Name:

Location:

Quantity:

Finish Color:

Glass Color:

Notes: