

HAMMERTON

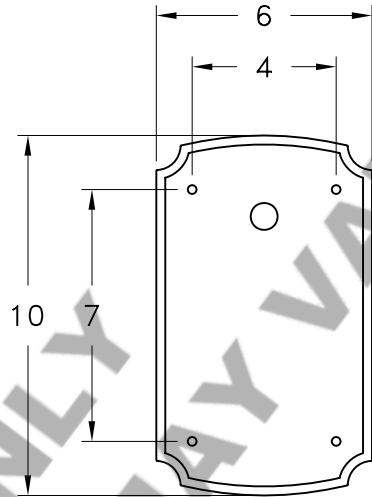

MOUNTING DETAIL

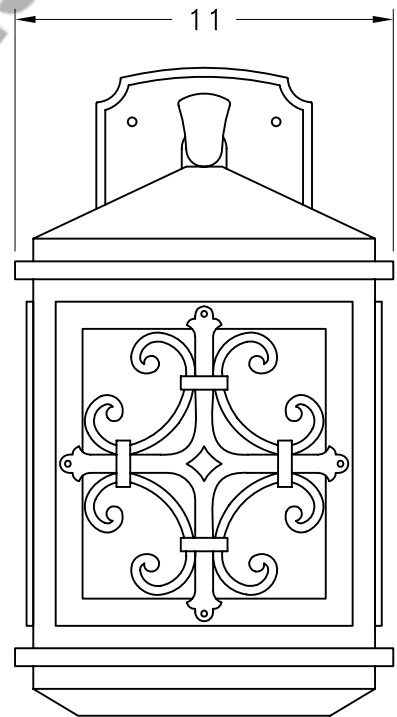
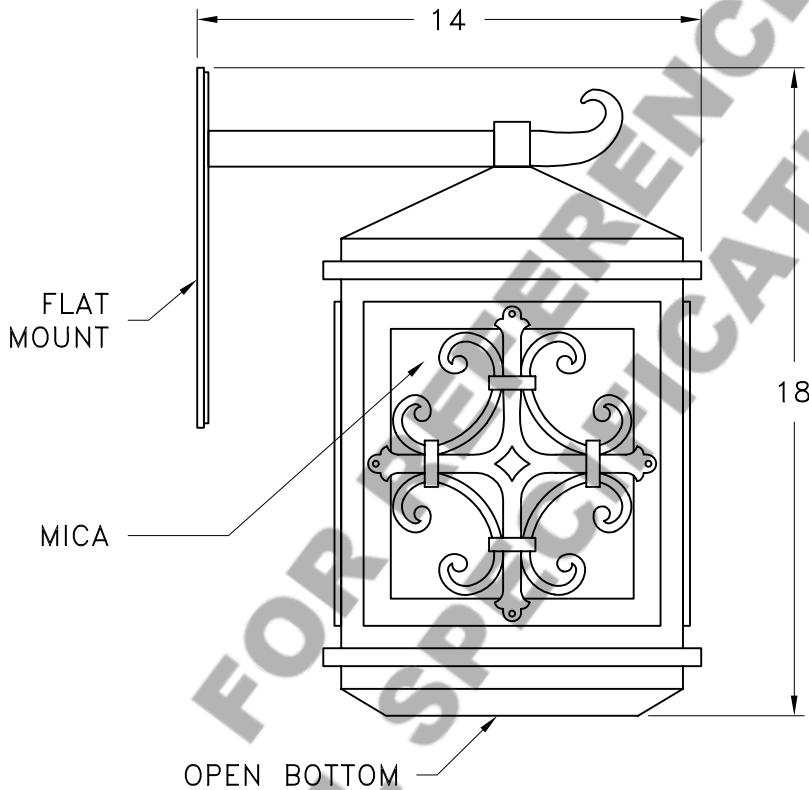

MOUNTING SPECIFICATION NOTES:

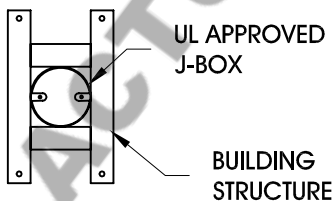

CAUTION
HARDWARE PACKET "C" MOUNTS DIRECTLY TO BUILDING STRUCTURE.

ELECTRICAL SPECIFICATION NOTES:



**ELECTRICAL: 1-100 WATT MAX
EDISON BASE
120v TYPICAL**

Light Bulb NOT Included

CATALOG # OD9152

APPROXIMATE WEIGHT: 32 Lbs.

HARDWARE PACKET: C

SHADE MATERIAL : MICA

UL RATING: DAMP

DIMENSION TOLERANCE ± 7/8".

www.hammerton.com

© Copyright 2006, All rights in design, detail or invention of this drawing are reserved as the property of Hammerton. Any imitation or adaptation without written consent is strictly prohibited.